

BRESLE TEST KIT
SP7310

INDEX

1	Instrument Data	4
1.1	Product Description	
1.2	Name/Article	
1.3	Standards	
1.4	Scope of Supply	
2	Instrument Layout and Functions	5
3	Preparations	6/7
3.1	Determine Test Area	
3.2	Instrument Preparations	
3.3	Calibration	
4	Use	8/10
5	ISO 11127-6	11
6	Maintenance	11
7	When Something Goes Wrong	11
8	Disclaimer	11

1 INSTRUMENT DATA

1.1 Product Description

The TQC Sheen Bresle Kit complies with the ISO 8502-6 and ISO 8502-9 standards that describe the Bresle Method to assess the level of soluble salts using a Bresle patch or Bresle sampler, distilled water and a conductivity gauge. The conductivity is mainly directly proportional to the concentration of dissolved chloride ions in the solution. The kit includes all the necessary equipment to execute a Bresle test that will indicate the contamination of soluble salts on blast-cleaned surfaces prior to coating. Inside the Bresle Kit is a conductivity gauge used for the assessment of soluble salt ions as chlorides, sulphates and nitrates.









1.2 Name / Article

SP7310 Bresle Test Kit

1.3 Standards

ISO 8502-6, ISO 8502-9, ISO 11127-6

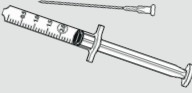
1.4 Scope of Supply

 Case	 Digital Conductivity Meter	 Bresle Patches, 25 pieces	 Deionised Water	 Calibration Solution
 Cleansing Solution	 Cup	 Syringe	 Manual	

2 INSTRUMENT LAYOUT AND FUNCTIONS

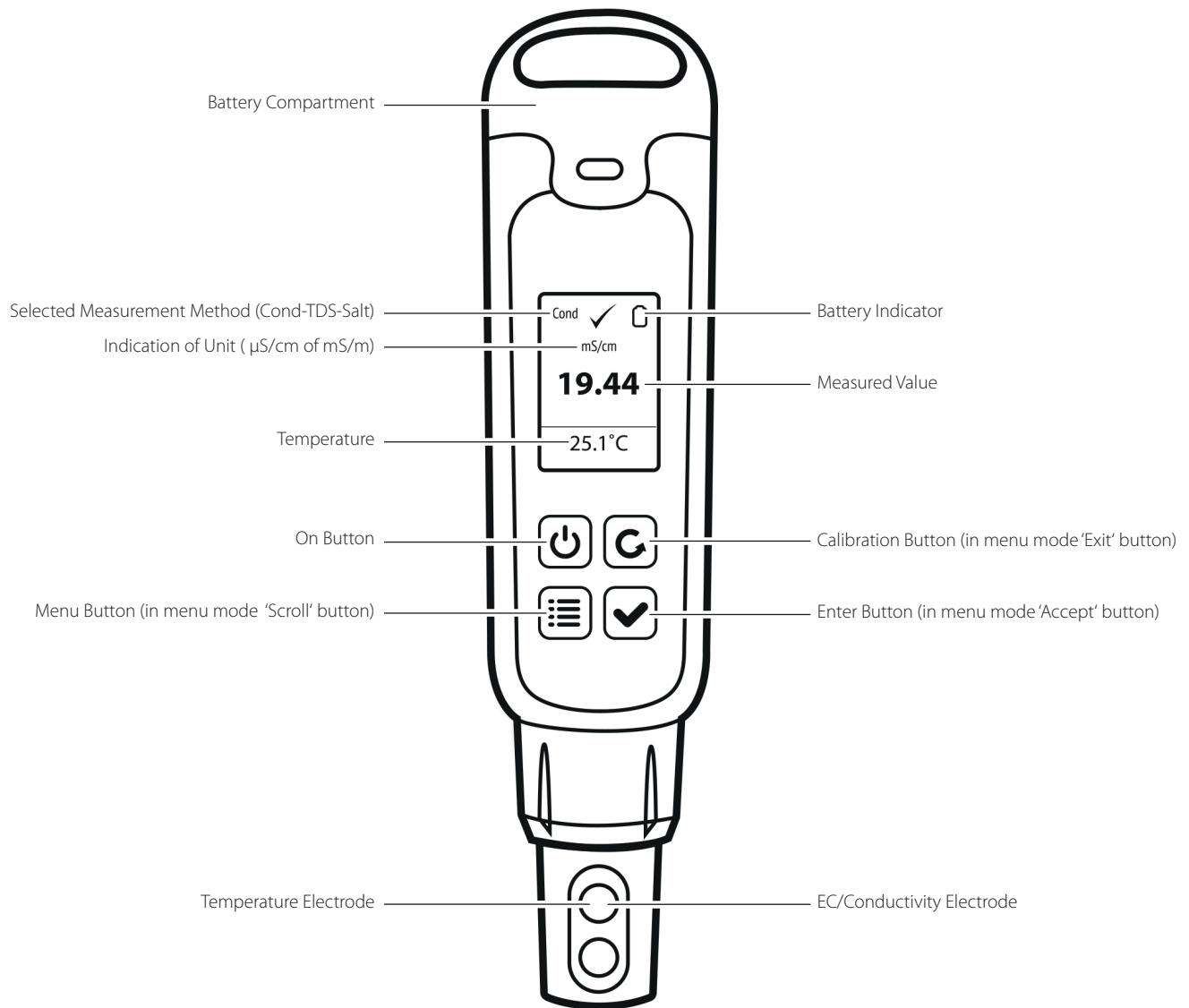

3 PREPARATIONS

3.1 Determine Test Area

Select the section on the steel surface to be used as the test area for assessment of the total surface density of salts. It should preferably be dry and with no loosely adherent rust, dirt or moisture (dampness), so that the patch frame can properly adhere to the surface. The Bresle patch can be placed in almost every position, vertical, horizontal, slanting or on surfaces that are not completely flat.

i *It is recommended to test more than one spot to catch the variations of the contamination level!*

3.2 Instrument Preperation

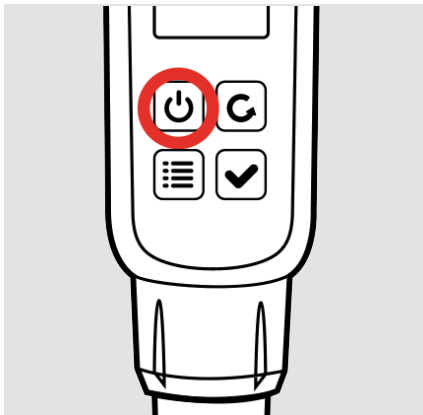

① Turn on the Digital Conductivity Meter.

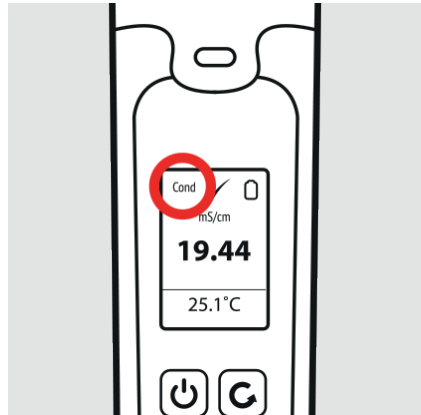

② Check whether 'COND' is shown at the top left. If so, perform the measurement. If not, go through the following steps:

- ▶ Click on menu button.
- ▶ Scroll with the 'menu / scroll' button until 'measure' is selected.
- ▶ Confirm with the 'enter / accept' button.
- ▶ Scroll with the 'menu / scroll' button until 'COND' is selected.
- ▶ Confirm with the 'enter / accept' button. Press 'calibration / return' button to return to the measurement screen.
- ▶ COND is shown at the top left.

3.3 Calibration

Calibration prior to each use is desirable for a reliable measurement.

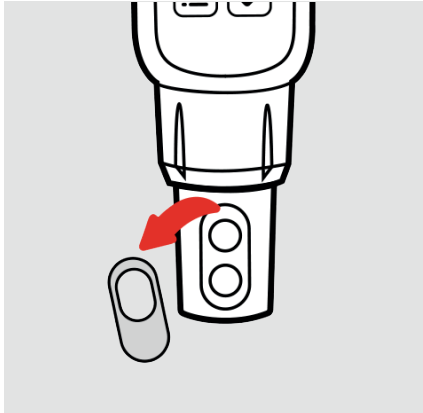

① Remove the plastic cap from the measuring cell.

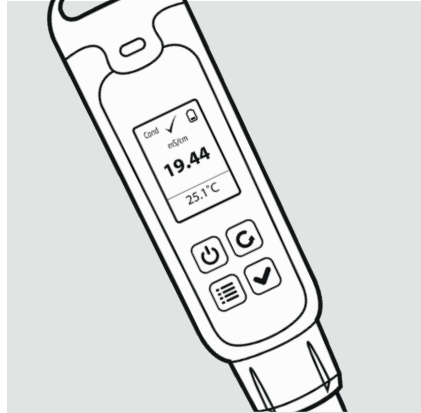

② Place the gauge flat on a flat surface.

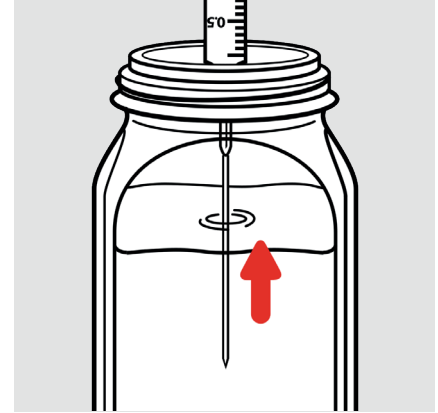

③ Fill up the syringe with deionised water.

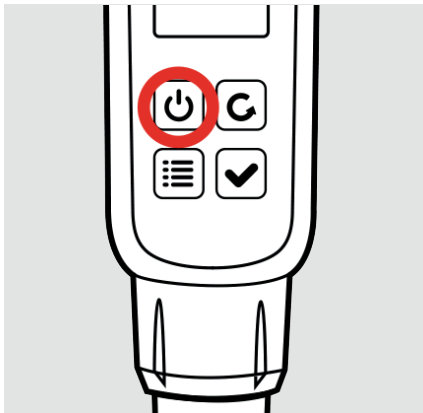

④ Turn on the Digital Conductivity Meter.

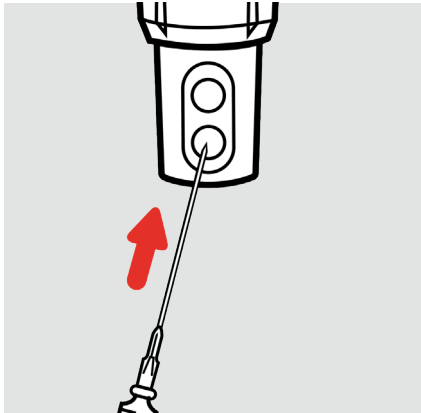

⑤ Inject the deionised water in the measuring cell.

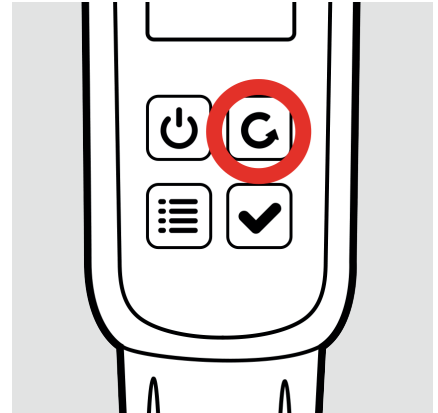

⑥ Push the CAL button. Wait until the measurement is stabilized.

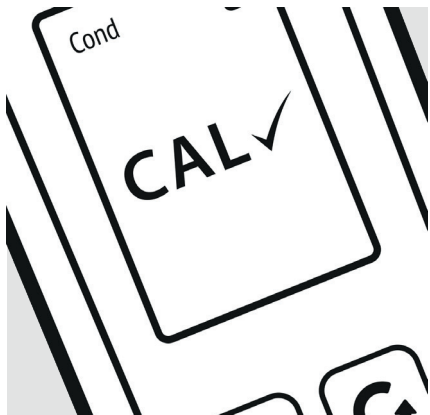

⑦ The display shows CAL ✓, the calibration was successful.

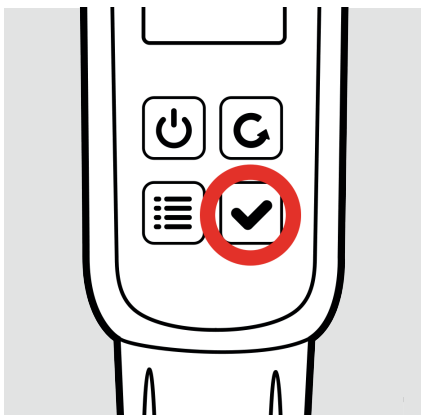

⑧ Push the enter button to return to the normal display.

4 USE

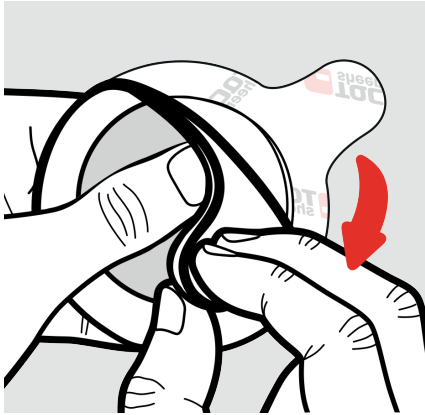

- ① Remove the protective backing of the Bresle patch with its inner protective paper and dispose.

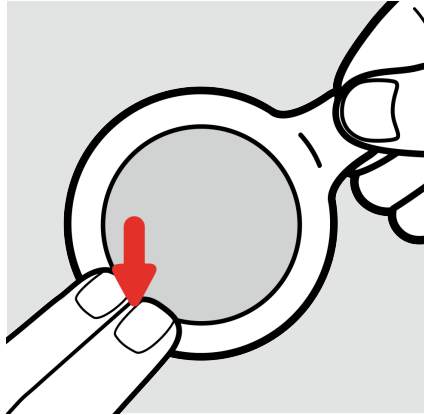

- ② Place the Bresle patch with the adhesive side to the test surface.

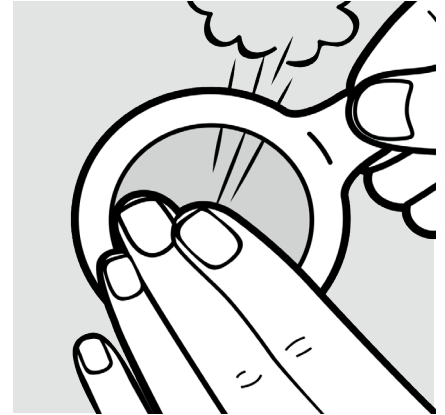

- ③ Take care to trap as less air as possible in the patch.

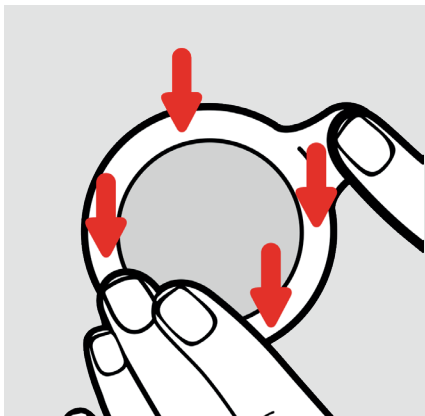

- ④ Press firmly in order to create a tight seal.

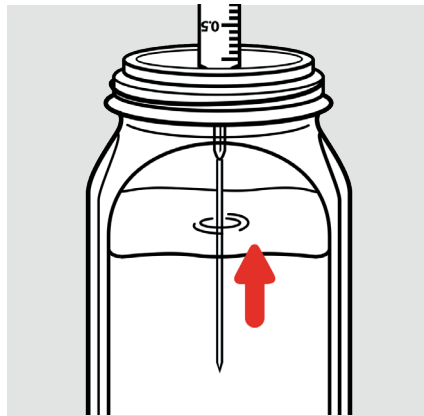

- ⑤ Fill up the syringe with deionised water.

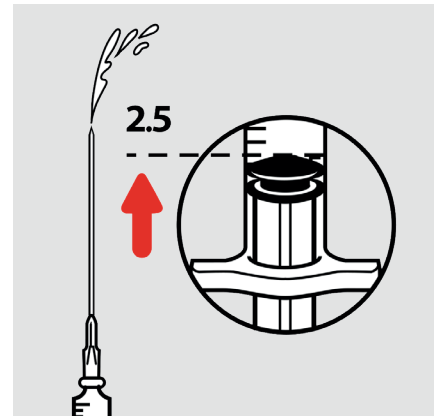

- ⑥ Empty the syringe until there is 2,5 ml left to take care that there are no air bubbles in the syringe.

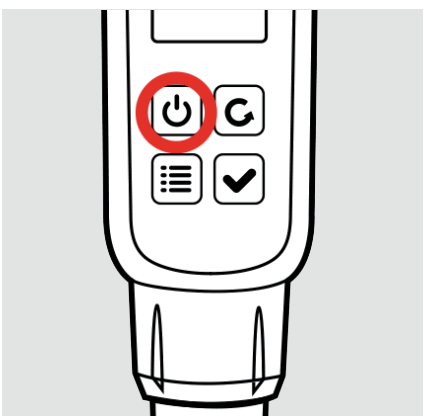

- ⑦ Turn on the Digital Conductivity Meter.

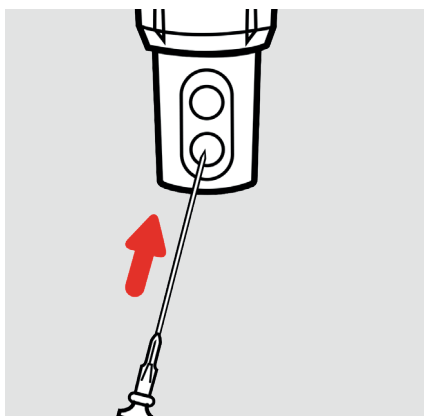

- ⑧ Inject the deionised water in the measuring cell until it runs over.

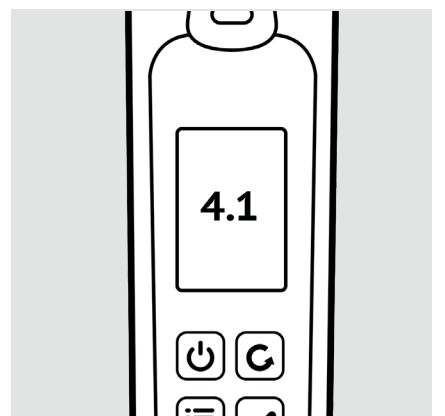

- ⑨ A value is shown on the display.

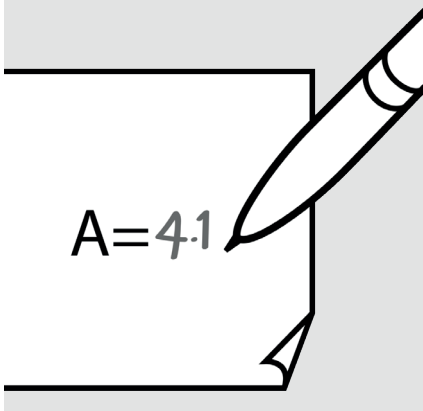

⑩ Write down the value as blank value.

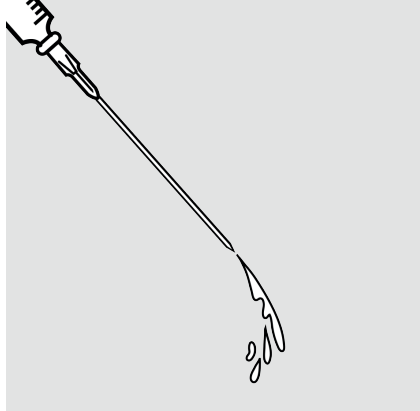

⑪ Empty the syringe.

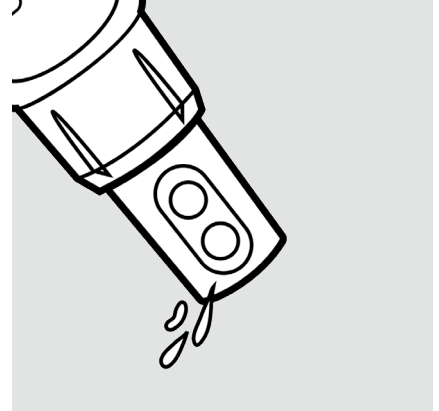

⑫ Empty the meter.

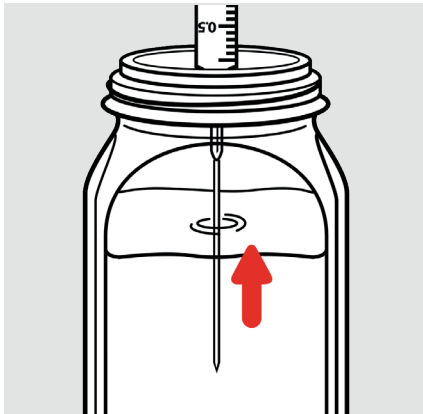

⑬ Fill up the syringe with deionised water.

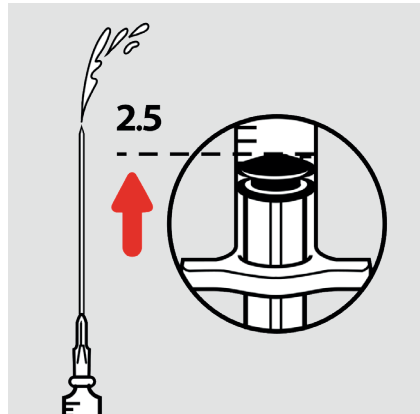

⑭ Empty the syringe until there is 2,5 ml left to take care that there are no air bubbles in the syringe.

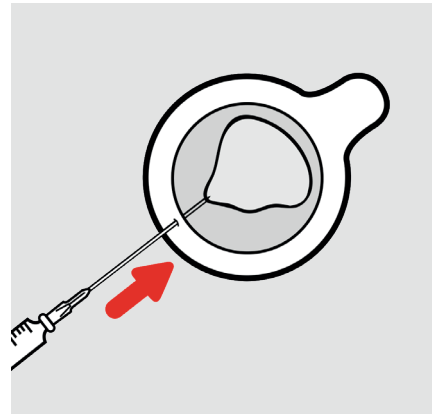

⑮ Insert the 2,5 ml of deionised water into the Bresle patch by injecting it through the foam at an angle of 30° from the surface.

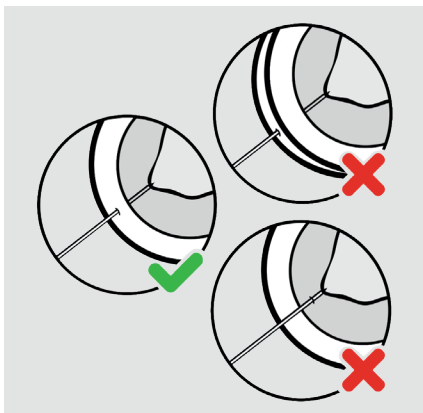

⚠ **Inserting through the transparent part of the Patch or through the bottom side could cause leakage!**

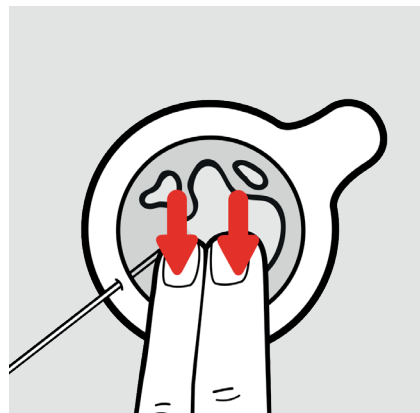

⑯ Dissolve the salts by tapping the membrane for 90 seconds.*

** ISO 8502-6 recommended time is 10 minutes.
Most users test at 90 seconds. Always agree on test time prior to testing.*

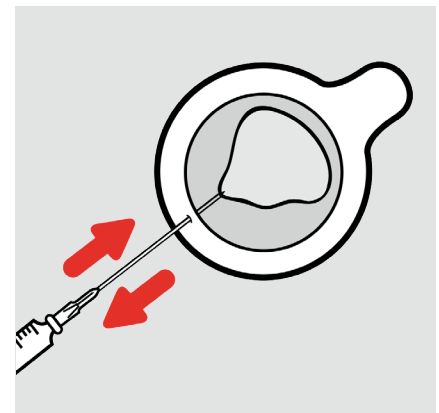

⑰ Extract the water from the patch and reinject into the patch 4 times.

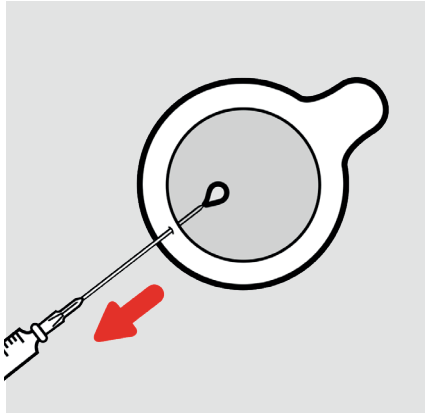

18 When finished, extract the entire volume of water into the syringe and remove the syringe from the Bresle Patch.

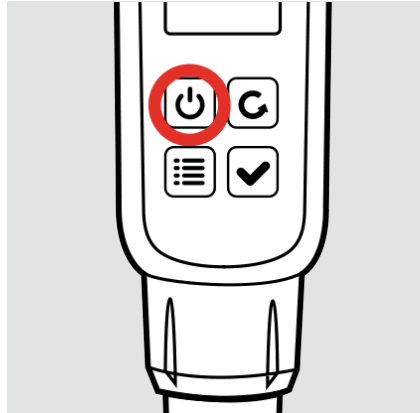

19 Turn the Digital Conductivity Meter back on.

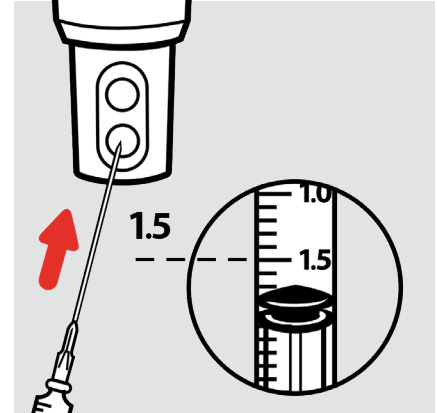

20 Inject 1,5 ml of this water into the measuring cell of the Conductivity Meter.

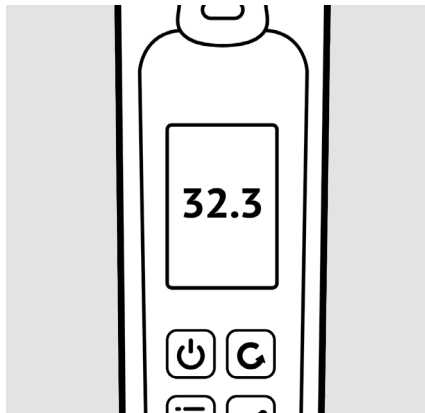

21 A value is shown on the display.

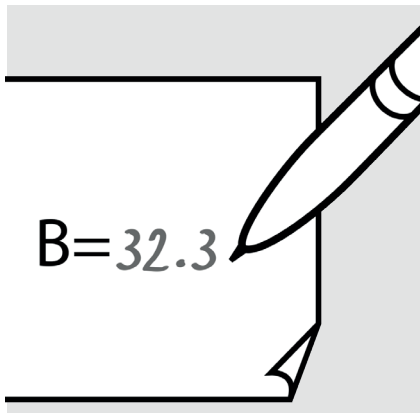

22 Write down the measured value.

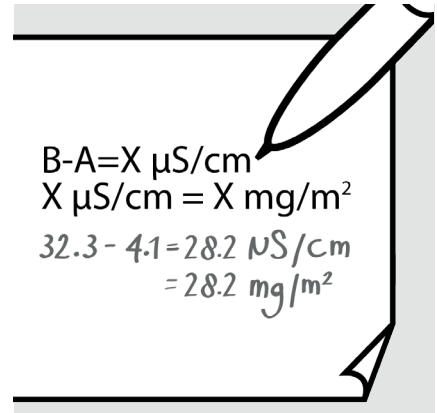

23 Calculate the difference between the measured value and the blank value. (measured value - blank value).

The total surface density of soluble salts/contaminants (S) in mg/m² soluble salts measured as Sodium Chloride is 1 x (measured value – blank value).

(All salts are considered as NaCl or Sodium Chloride). "Sample Value" and "Zero Reference" are in microSiemens (μS) per centimeter.

i If an interpretation of just the chlorides or cl- is required the multiplier will be 0.6 instead of 1!

5 ISO 11127-6

Determination of the water soluble salts in mineral abrasives, conform ISO 11127-6.

- ▶ Collect a number of samples , minimum 5, of the abrasive at random at different places.
- ▶ Mix them well and take 100 g from this mix into a 100 ml. beaker.
- ▶ Pour 100 ml. distilled water into a 250 ml. beaker which has been cleaned before with distilled water.
- ▶ Take a reading of this water with the conductivity gauge and note the value. This is the "Zero Reference"
- ▶ Add 50 g of abrasives to the 100 ml distilled water in the 250 ml. beaker.
- ▶ Shake the mixture well for about 5 minutes and leave it for one hour. Shake again for 5 minutes.
- ▶ Decant some of the water into a clean beaker and measure the conductivity.

Contact the paint-manufacturer, abrasive supplier or project-manager for the maximum acceptable conductivity level

6 MAINTENANCE

Maintenance of the conductivity meter is minimal, because it's quite easy to perform a measurement. Nevertheless the technology inside the instrument is very advanced.

- ▶ Depending on the frequency of use, a thin film may occur on the probe. Use a damp cloth to remove this.
- ▶ After each use the instrument should be rinsed with tap water and demineralized liquid. Make sure the probe stays clean.
- ▶ A blinking battery indicator indicates the batteries need to be replaced. Open the battery compartment cover. Note polarity facing up and remove the old batteries. Replace with fresh ones with the same polarity. facing up as the old ones.

7 WHEN SOMETHING GOES WRONG

When the instruments doesn't perform the way you expected, usually you can solve it yourself easily. Therefore read this part thoroughly before claiming warranty.

The value measured is unstable <i>Possible cause: Pollution?</i>	Clean the measuring cell with a damp soft cloth and rinse the measuring cell thoroughly with demiwater afterwards.
Display fails <i>Possible cause: Insufficient battery power.</i>	Replace batteries
Calibration fails <i>Possible cause: Dirty measuring cell or old / polluted calibration standard.</i>	Always use a 'fresh ' calibration standard. Once opened the calibration standard will not keep.

8 DISCLAIMER

The right of technical modifications is reserved.

The information given in this sheet is not intended to be exhaustive and any person using the product for any purpose other than that specifically recommended in this sheet without first obtaining written confirmation from us as to the suitability of the product for the intended purpose does so at his own risk. Whilst we endeavour to ensure that all advice we give about the product (whether in this sheet or otherwise) is correct we have no control over either the quality or condition of the product or the many factors affecting the use and application of the product. Therefore, unless we specifically agree in writing to do so, we do not accept any liability whatsoever or howsoever arising for the performance of the product or for any loss or damage (other than death or personal injury resulting from our negligence) arising out of the use of the product. The information contained in this sheet is liable to modification from time to time in the light of experience and our policy of continuous product development.

